

### Theoretical Investigations on a Binary Energetic Nitrogen-rich Compound $\text{PN}_3$

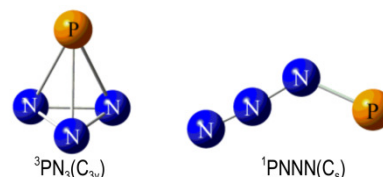

The singlet and triplet potential energy surfaces of nitrogen-rich compound  $\text{PN}_3$  were constructed at the CCSD(T)/aug-cc-pVTZ//M06-2X/6-31+G(d,p) level. The kinetic stability of  $\text{PN}_3$  was evaluated by studying the dissociation, isomerization as well as the Born-Oppenheimer molecular dynamic (BOMD) simulations at the B3LYP/6-31+G(d) level.

GAO Si-meng, LIU Ying-qi, KANG Zhi-hong, LIU Nan-nan, GU Di, WANG Bao-hui

*Chinese Journal of Energetic Materials*, 2019, 27(5): 357–362

### Numerical Simulation of the Internal Crystalline Structure of TNT Melt-Cast Explosive

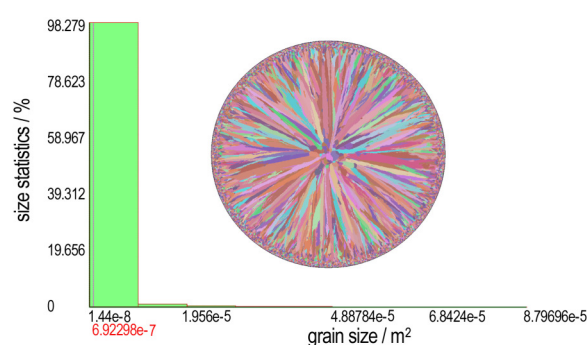

The internal crystallization structure of TNT cast explosive was numerically simulated by using CA-FE coupling model. In order to improve micro quality of explosive column, the corresponding process optimization measures were put forward.

LIU Yu-di, CAO Hong-song, LIU Sheng, ZHANG Heng, ZHANG Xiao-dong, XIE Feng

*Chinese Journal of Energetic Materials*, 2019, 27(5): 363–370

### Numerical Prediction of Fast Cook-off Characteristics for Modular Charges

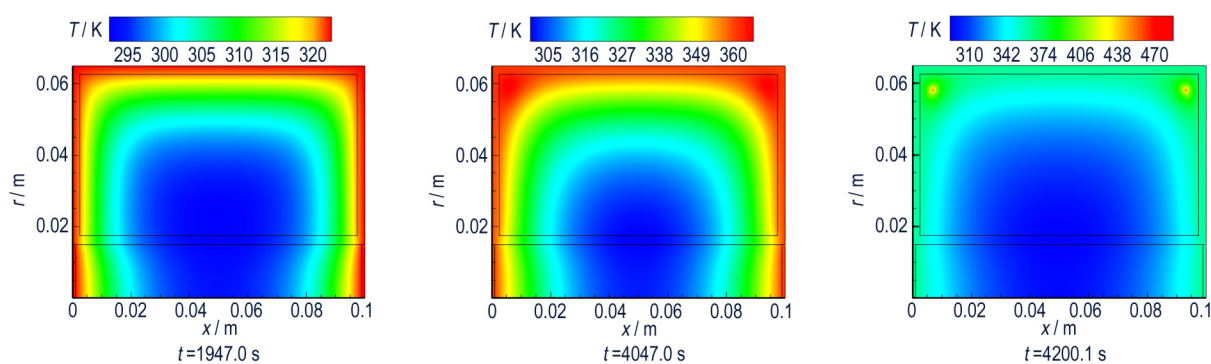

A 2D unsteady state fast cook-off combustion model of modular charge was established. Through the numerical simulation, the ignition temperature, ignition time and first response areas of modular charge under the fast cook-off condition were obtained. Then, the fast cook-off response characteristics of modular charge were analyzed at different heating rates.

LIU Jing, YU Yong-gang

*Chinese Journal of Energetic Materials*, 2019, 27(5): 371–376

### Simulation of the Dissolution Characteristics of RDX in Ethyl Acetate-Water Binary Mixed Solvent

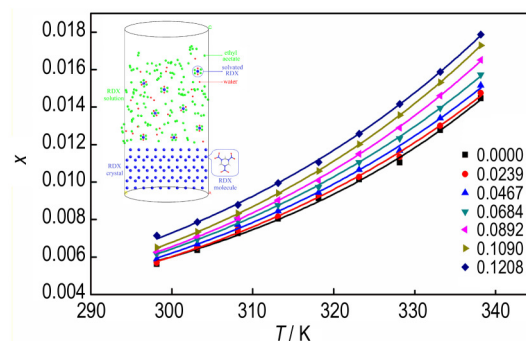

The solubility of RDX in ethyl acetate-water binary system at temperatures ranging from 298.15 K to 338.15 K was measured by a gravimetric method under atmosphere pressure and the solubility parameter was calculated using molecular dynamics (MD) simulation to research the dissolution mechanism of RDX in ethyl acetate-water binary system on the molecular level.

LI Jing, JIN Shao-hua, XU Zi-shuai, WU Na-na, LAN Guan-chao, CHEN Shu-sen, WANG Dong-xu

*Chinese Journal of Energetic Materials*, 2019, 27(5): 377–384

### Numerical Simulation for the Process of Breaking Explosives by High Pressure Water Jet

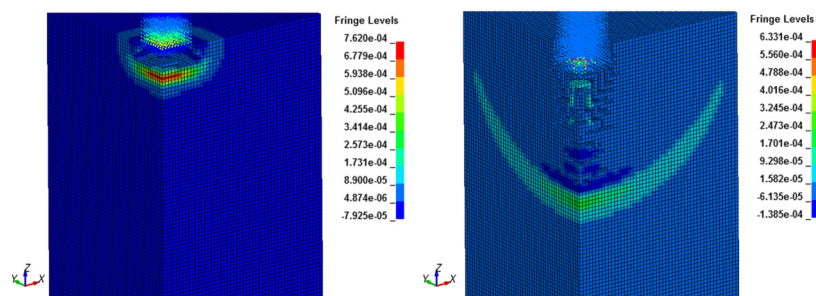

A finite element calculation model with high pressure water jet velocity as the input parameter was set up. The Lagrange algorithm and SPH (Smoothed particle hydrodynamics) algorithm were used to solve the problem with DYNA solver. The safety of breaking explosives by high pressure water jet is studied through the analysis of pressure, temperature and reaction degree of explosive, and the effectiveness of breaking explosives by high pressure water jet was analyzed through the number analysis of failure unit.

HUANG Yu-ping, CUI Qing-zhong, XU Yang, CHEN Ming-hua, WU Xing-yu

*Chinese Journal of Energetic Materials*, 2019, 27(5): 385–391

### Preparation of High-performance CNA and Its Application in HMX-based Mixed Explosives

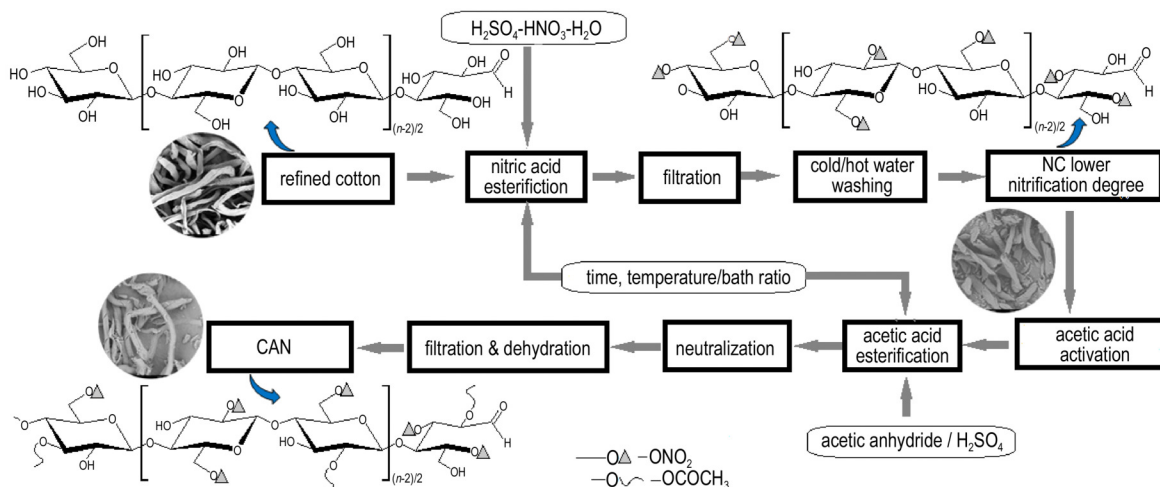

Using refined cotton as raw material, nitric acid esterification was carried out in nitrification system of  $\text{H}_2\text{SO}_4\text{-HNO}_3\text{-H}_2\text{O}$ . NC intermediates with nitrogen content of  $6\% \pm 0.05\%$  and  $10\% \pm 0.05\%$  were prepared by controlling nitrification process. After activation in acetic acid, NC intermediates were esterified by sulfuric acid/acetic anhydride mixed solution. Cellulose nitrate-acetate mixed ester was obtained after using magnesium acetate to neutralize, precipitation, filtration, washing, drying, and crushing.

LIU Yan-hua, SHAO Zi-qiang, ZHANG Xin-fang, YUAN Jing-jing, PENG Huan, SUN Jian-gang, ZHAO Li-bin, ZHANG Ren-xu  
*Chinese Journal of Energetic Materials*, 2019, 27(5): 392–397

### Mechanical Property of Paraffin/HTPB Fuel

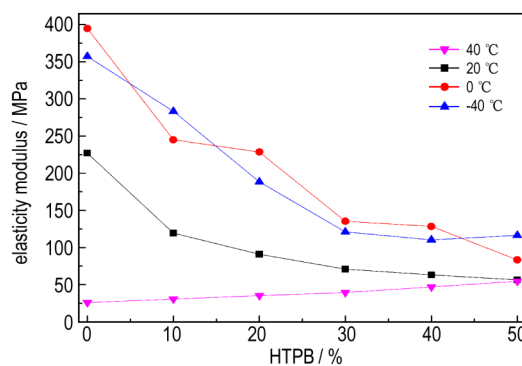
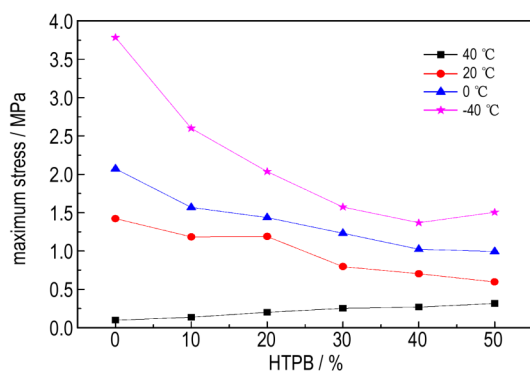

Seven different paraffin/HTPB fuels were prepared and the effect of mass fraction of HTPB and temperature on mechanical property of paraffin/HTPB fuels was studied by tensile test.

WANG Yin, WANG Fei, HU Song-qi, LIU Lin-lin, LIU Hui  
*Chinese Journal of Energetic Materials*, 2019, 27(5): 398–403

### Influence Rule of End Face Friction on Static Compressive Strength of Polymer Bonded Explosive (PBX)

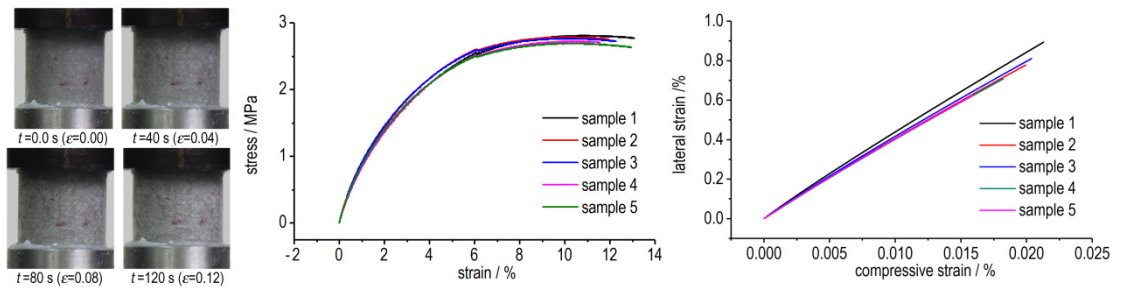

A typical casting polymer-bonded explosive (PBX) was selected to study the response to quasi-static compression under different end face friction conditions, such as molybdenum disulfide lubrication, dry friction, and grease lubrication. The load-displacement curves were obtained by electronic universal material testing machine. Based on the isotropic elastic theory, the friction mechanism of the end face is discussed by the energy conservation method.

SUN Wen-xu, LUO Zhi-heng, LI Ming, LIU Tong, HUANG Heng-jian, ZHANG Ding-guo

*Chinese Journal of Energetic Materials*, 2019, 27(5): 404–409

### Uniaxial Quasi-static Stress-strain Relationship of TATB-based PBX Based on SVM Algorithm

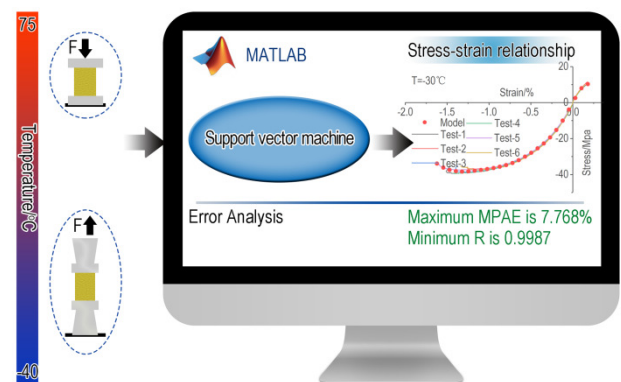

The quasi-static uniaxial tension and compression tests of TATB-based PBX were carried out within the temperature range of  $-40\text{ }^{\circ}\text{C}$  to  $75\text{ }^{\circ}\text{C}$ , and the stress-strain relationship was described via support vector machine (SVM) algorithm. As a novel method to establish the stress-strain relationship, it has superior performance in accuracy and adaptability.

DUAN Xiao-chang, SUN jie, LIU Ying-bin, CHANG Shuang-jun, ZHAO Long, YUAN Hong-wei, TANG Wei

*Chinese Journal of Energetic Materials*, 2019, 27(5): 410–416

### Characterization of High-Voltage Capacitor Discharge Unit Based on MOS Controlled Thyristor

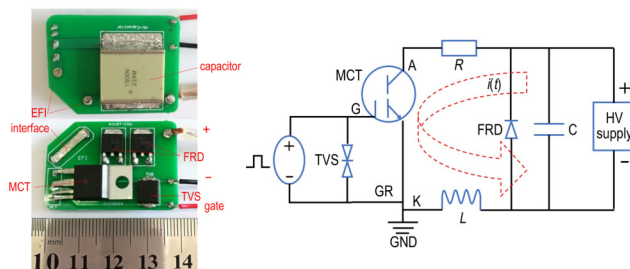

A capacitor discharge unit(CDU) including MOS control thyristor (MCT) switch and high voltage ceramic capacitor was prepared, and the characteristics of MCT and discharge performance of CDU were studied. The effects of different capacitance and switches on the discharge performance of CDU were studied by controlling variable. The discharge performance of CDU based on MCT switch was verified by using exploding foil initiator and boron-potassium nitrate(BPN) ignition powder.

QIN Xin, ZHU Peng, XU Cong, YANG Zhi, ZHANG Qiu,  
SHEN Rui-qj

*Chinese Journal of Energetic Materials*, 2019, 27(5): 417–425

### Design and Feasibility of an Addressable Initiation Network System

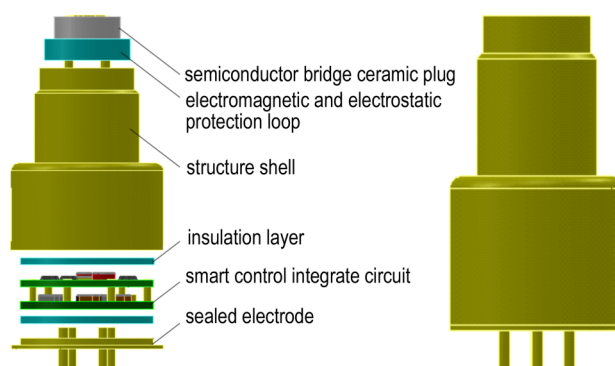

Smart initiator was integrated multifunction module which include antistatic, information identification, embedded “ID” in ROM electronic safe/arm, real time voltage monitor circuit, fire circuit and semiconductor bridge chip.

YIN Guo-fu, ZHANG Jin-cheng, REN Xi, HAN Ke-hua, LI Li-ming  
*Chinese Journal of Energetic Materials*, 2019, 27(5): 426–433

### Progress in the Applied Research of Small-angle Scattering Technique in Polymer Bonded Explosives

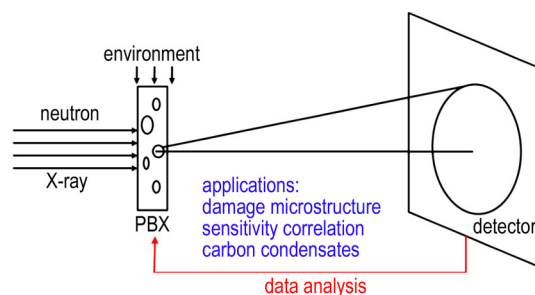

TIAN Qiang, YAN Guan-yun, BAI Liang-fei, LIU Jia-hui,  
CHEN Ke-ping, LIN Cong-mei, CHEN Hua, DUAN Xiao-hui, LIU Yu,  
LI Jing-ming, CHEN Bo  
*Chinese Journal of Energetic Materials*, 2019, 27(5): 434–444

The experimental methods, data analysis and applications of the small-angle scattering techniques in the polymer bonded explosive research were reviewed.

Executive editor: GAO Yi WANG Yan-xiu ZHANG Qi JIANG Mei