

Effect of Cocrystallizing and Mixing on the Sensitivity and Thermal Decomposition Mechanisms of CL-20 /DNB via MD Simulation

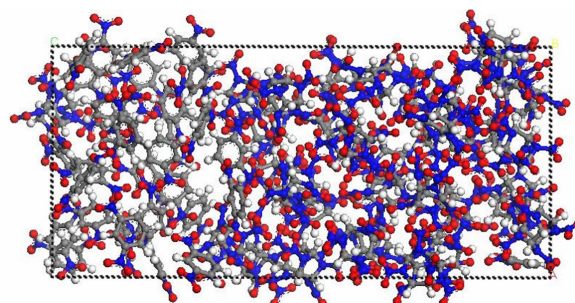
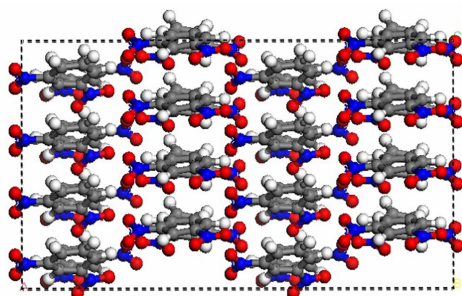

FU Yi-zheng, KANG Zhi-peng, GUO Zhi-jing, MIAO Rui-zhen, MENG Rui-hong, YANG Lu-xia, LIU Ya-qing

Chinese Journal of Energetic Materials, 2017, 25(2) : 94–99

Effect of cocrystallizing and mixing on the sensitivity, binding energy, mechanical properties and thermal decomposition mechanisms of CL-20/DNB was studied by MD simulation with COMPASS force field and RMD simulation with ReaxFF/lg force field.

Theoretical Investigations on Fundamental Properties of All-Nitrogen Materials: I. Prediction of Crystal Densities

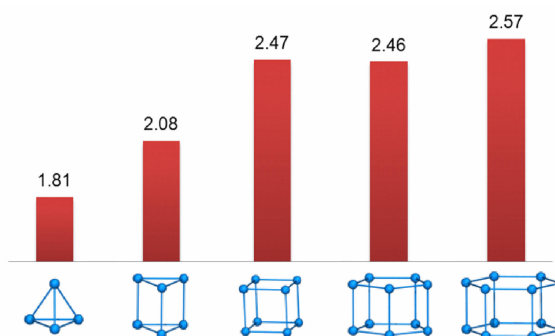

LIU Ying-zhe, LAI Wei-peng, YU Tao, GE Zhong-xue, XU Tao, LUO Yan-jiao, YIN Shi-wei

Chinese Journal of Energetic Materials, 2017, 25(2) : 100–105

The force field parameters for specific all-nitrogen molecules were calculated on the basis of quantum chemical method, and the crystal densities of five representative all-nitrogen molecules with cage structure were predicted by molecular mechanics methods.

Numerical Simulation and Verification of Porous Nitroguanidine Gun Propellant Extrusion

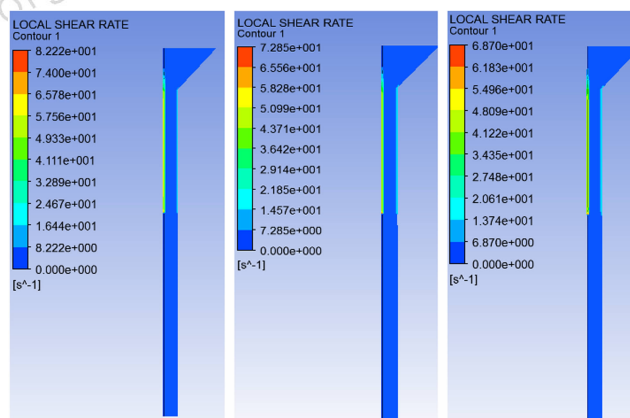

CHANG Fei, NAN Feng-qiang, HE Wei-dong

Chinese Journal of Energetic Materials, 2017, 25(2) : 106–112

The shear rate field, pressure field and velocity field of porous nitroguanidine gun propellant in different extrusion processes were analyzed by the FEM method. The sizes of 7-pore NGu gun propellant were measured and compared with simulation sizes.

Failure Zone of PBX Mode I Crack Tip Based on Three Strength Criteria

DONG Tian-bao, TANG Wei, WEN Mao-ping,
ZHANG Wei-yao, WEI Xing-wen

Chinese Journal of Energetic Materials, 2017, 25(2): 113–117

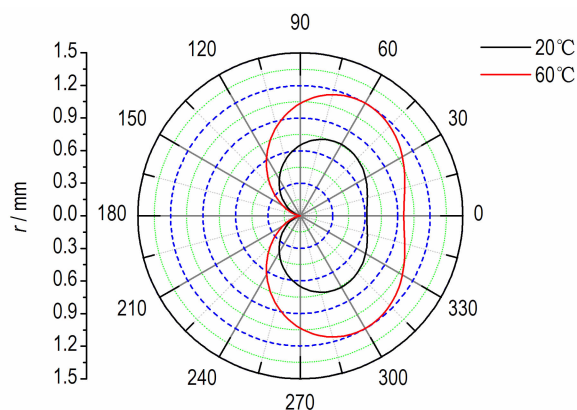

PBX mode I crack tip failure zone was calculated based on Mohr-Coulomb, Twin-shear or Drucker-Prager strength criterion. The influences of tension-compression strength ratio and temperature on the crack tip failure zone were studied.

Application of Peridynamic Method on Prediction of Creep Behavior of Polymer Bonded Explosives

LI Pan, HAO Zhi-ming, LIU Yong-ping, ZHEN Wen-qiang

Chinese Journal of Energetic Materials, 2017, 25(2): 118–124

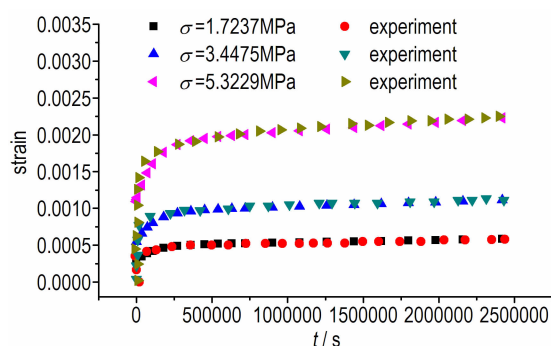

The expressions of creep compliance under different stresses and the peridynamic creep response functions are deduced combining time-stress equivalence principle of nonlinear viscoelastic materials and utilizing Burgers viscoelastic model. The creep behavior of PBX9502 is simulated.

Synthesis, Structure and Properties of an Energetic Coordination Polymer $[\text{Pb}(\text{BTO})(\text{H}_2\text{O})]_n$

SHANG Yu, JIN Bo, LIU Qiang-qiang, PENG Ru-fang,
GUO Zhi-cheng, ZHANG Qing-chun, CHU Shi-jin

Chinese Journal of Energetic Materials, 2017, 25(2): 125–131

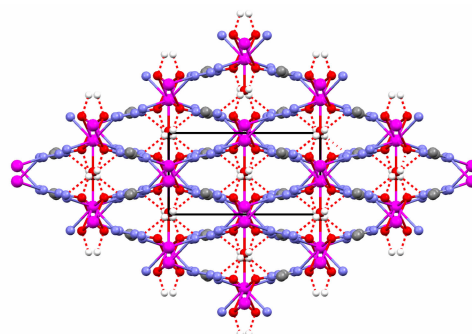

An energetic coordination polymer $[\text{Pb}(\text{BTO})(\text{H}_2\text{O})]_n$ was synthesized and characterized by single-crystal X-ray diffraction, FT-IR and elemental analysis. Its thermal decomposition process and non-isothermal kinetics analysis were investigated by using DSC and TG-DTG methods. In addition, the compound was explored as additive to promote thermal decomposition of ammonium perchlorate (AP) by DTA.

Research on the DNTF/HMX Based Booster Explosive Employed in the Microscale Explosion Network

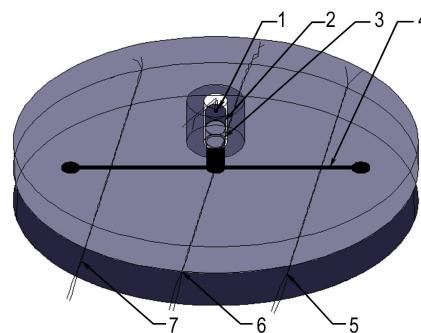

The DNTF/HMX based booster explosive was successfully designed and applied to the explosion network of microsize. The molding quality and fumble composition was characterized by SEM and XRD. The detonation performance, impact sensitivity, shock sensitivity and detonation velocity were also tested and analysed.

AN Chong-wei, WEN Xiao-mu, WANG Jing-yu, WEI Yan-ju, YU Bin-shuo

Chinese Journal of Energetic Materials, 2017, 25(2): 132–137

Front Curvature Rate Stick Experiment of TATB Based Insensitive High Explosives at High Temperature

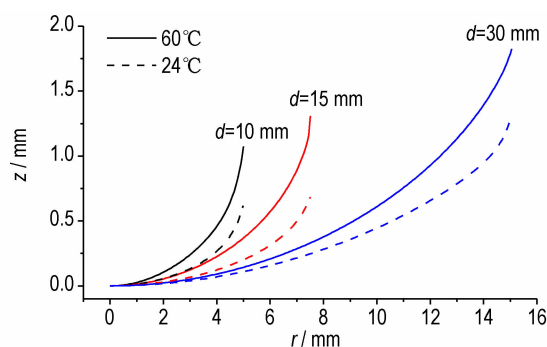

Steady-state detonation velocities and wave shapes were obtained for TATB Based Insensitive High Explosives (IHEs) with three different diameters at the temperature 60 °C by using high speed streak camera technique and electric foil velocimetry.

GUO Liu-wei, LIU Yu-si, WANG Bin, GU Yan, ZHENG Xian-xu, TAN Duo-wang

Chinese Journal of Energetic Materials, 2017, 25(2): 138–143

Measurement and Analysis of Expansion Characteristics of Pulsed Plasma Jet in Liquid Medium

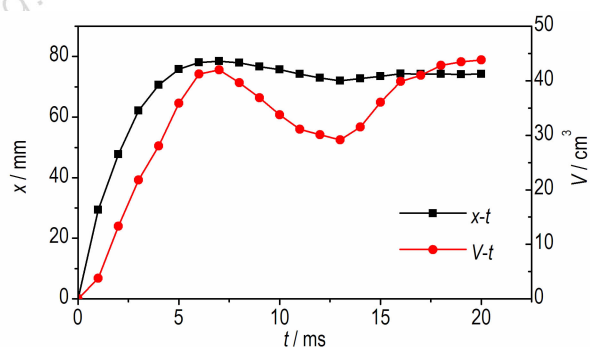

The expansion process of pulsed plasma jet in liquid medium was observed by a high-speed video system. The changes in axial displacement and volume of Taylor cavity were measured. The expansion law for the change of Taylor cavity volume was obtained. Effects of liquid chamber boundary shape, discharge voltage and nozzle diameter on the pulsed plasma jet expansion were discussed.

LIU Yi, YU Yong-gang, MANG Shan-shan

Chinese Journal of Energetic Materials, 2017, 25(2): 144–149

Ionic Chromatogram Method for Quantitative Analysis of Trace Component in Nano-TATB

CHEN Ling, LI Zhe, ZHAO Ying-bin, PANG Xiao-qing,
HUANG Bo-yong
Chinese Journal of Energetic Materials, 2017, 25(2) : 150–154

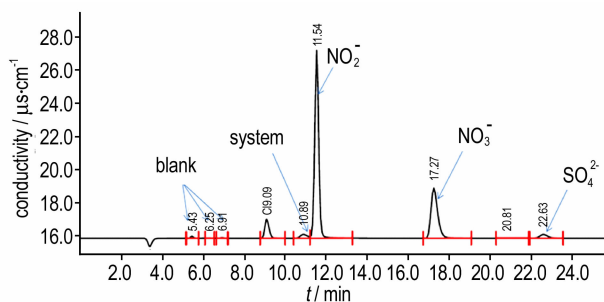

Chlorine and sulfate in nano-TATB were determined by oxygen flask combustion-ionic chromatogram method.

Prepolymerization Reaction Kinetics of Acrolein-pentaerythritol Resin by Online IR Technology

SHI Yuan-tong, LIU Hui-hui, LUO Guan, CAI Jia-lin
Chinese Journal of Energetic Materials, 2017, 25(2) : 155–160

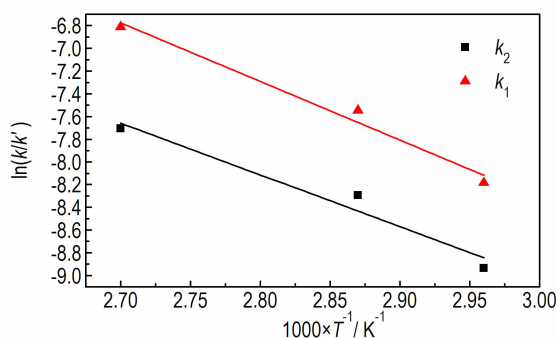
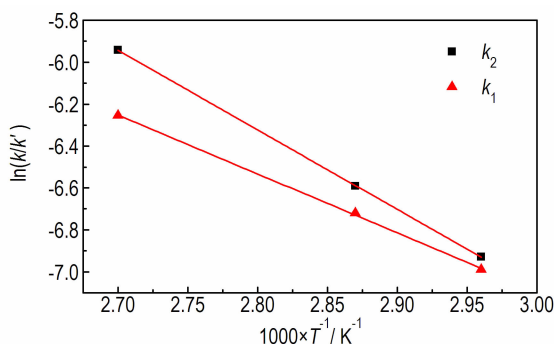

Online IR technology was used to research the prepolymerization reaction kinetics of acrolein-pentaerythritol resin. The reaction kinetic equation was obtained and the mechanical properties of cured product were studied.

Effect of RDX on Combustion Performance of Modified Single Base Propellant

FU You, WANG Bin-bin, XU Bin, LIAO Xin
Chinese Journal of Energetic Materials, 2017, 25(2) : 161–166

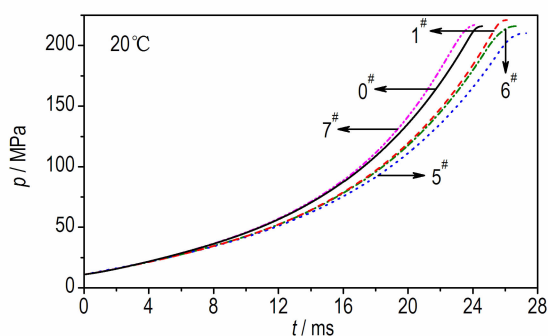

To improve the energy of a kind of single base propellant composed of NC, DNT, DBP and DPA, RDX with different contents and different particle sizes were added into this single base propellant, and the combustion performances of these modified single base propellants were analyzed.

Effect of Sensitizing Methods on Detonation Performances of MgH_2 -based Hydrogen Storage Emulsion Explosives



The effects of sensitizing methods on the detonation performance of MgH_2 -based emulsion explosives were studied by underwater experiments and brisance testing experiments. The relationships between work capability and brisance of two kinds of MgH_2 -based emulsion explosives were also discussed.

CHENG Yang-fan, WANG Quan, SHEN Zhao-wu,
GONG Yue, TANG You-fu, YUAN He-ping, QIAN Hai
Chinese Journal of Energetic Materials, 2017, 25(2): 167–172

Characterization of TATB Molding Powder by X-ray Sub-micron Tomography

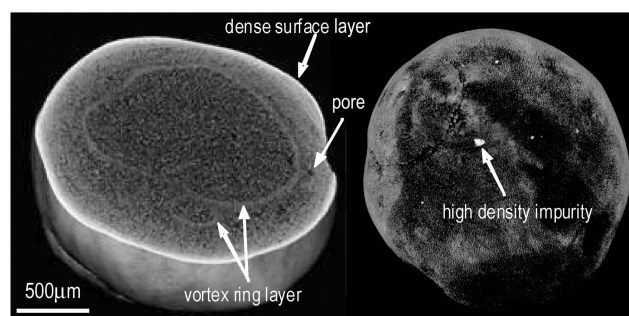

ZHANG Wei-bin, TIAN Yong, DAI Bin, DU Yu, LI Jing-ming,
CHEN Hua
Chinese Journal of Energetic Materials, 2017, 25(2): 173–176

Three dimensional visualization and quantitative analysis of 2,4,6-triamino-1,3,5-trinitrobenzene (TATB) molding powder was performed using X-ray sub-micron tomography.

Executive editor: GAO Yi ZHANG Qi WANG Yan-xiu JIANG Mei