

Friction Sensitivity of Nitramines. Part I : Comparison with Impact Sensitivity and Heat of Fusion

Marcela Jungová, Svatopluk Zeman, Adéla Husarová

Chinese Journal of Energetic Materials, 2011, 19(6) : 603 –606

Fractions of β -HMX (β -1,3,5,7-tetranitro-1,3,5,7-tetrazocane) have been used to demonstrate the mutual relationship between friction and impact sensitivities. Inclusion of an additional twelve nitramines into this scenario resulted in a series of partial relationships, which were determined from the molecular structure of these substances.

Friction Sensitivity of Nitramines. Part II : Comparison with Thermal Reactivity

Marcela Jungová, Svatopluk Zeman, Adéla Husarová

Chinese Journal of Energetic Materials, 2011, 19(6) : 607 –609

The friction sensitivity (FS) of five linear and eight cyclic nitramines has been determined. Arrhenius parameters of non-autocatalyzed thermal decomposition of these nitramines were used for comparison of the FS values with thermal reactivity.

Friction Sensitivity of Nitramines. Part III : Comparison with Detonation Performance

Svatopluk Zeman, Marcela Jungová, Adéla Husarová

Chinese Journal of Energetic Materials, 2011, 19(6) : 610 –612

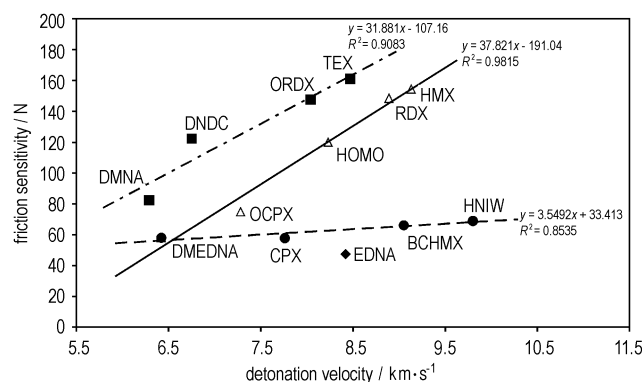

The friction sensitivities (FS) of five linear and eight cyclic nitramines have been determined.

Friction Sensitivity of Nitramines. Part IV : Links to Surface Electrostatic Potentials

Zdeněk Friedl, Marcela Jungová, Svatopluk Zeman, Adéla Husarová

Chinese Journal of Energetic Materials, 2011, 19(6) : 613 –615

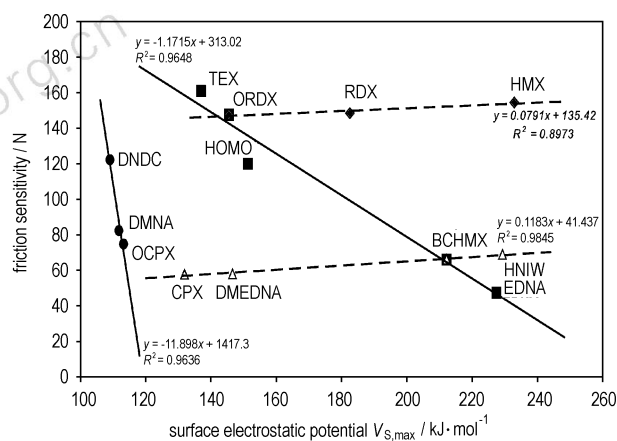

The friction sensitivity (FS) of five aliphatic linear and eight cyclic nitramines has been determined and correlated with DFT B3LYP/6-31-G(d,p) // 6-311 + G(d,p) positive ($V_{s,max}$) and negative ($V_{s,min}$) extremes of molecular surface electrostatic potentials $V_s(r)$.

Prediction of the Electrostatic Sensitivity of Nitro Compounds with Electrotological State Indices

ZHOU Lu-lu, JIANG Jun-cheng, PAN Yong, WANG Rui
Chinese Journal of Energetic Materials, 2011, 19(6) : 616 –620

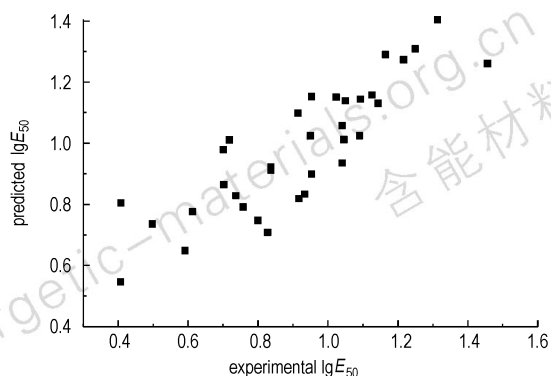

The relationship between the electrostatic sensitivity and the molecular structure for 16 kinds of nitramine compounds and 34 kinds of nitro aromatic compounds were established based on the theory of the electrotopological state (E-state). Quantitative structure-property relationship (QSPR) model by Multiple linear regression method were established.

Evaluation of Crystal Properties and Initiation Characteristics of Decreased Sensitivity RDX

HUANG Ming, LI Hong-zhen, XU Rong, ZHOU Xiao-qing, NIE Fu-de, CHEN Bo
Chinese Journal of Energetic Materials, 2011, 19(6) : 621 –626

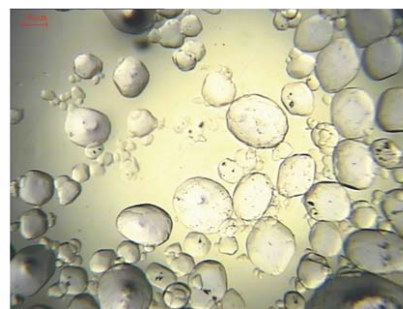

The crystal properties of decreased sensitivity of RDX (D-RDX), such as microstructure of inter crystalline voids, particle size and distribution, shape, morphology, were evaluated. And the shock wave sensitivities of D-RDX was characterized by using small scale-gap test.

Type of Ferrocenes on Sensitivities of Ultra-fine AP and Ferrocene Mixture

ZHANG Wei, YANG Jun, YU Yan, BAO Tong, LIU Xian-wei
Chinese Journal of Energetic Materials, 2011, 19(6) : 627 –631

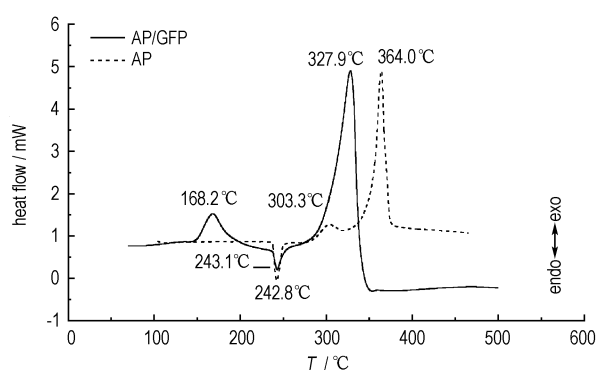

Impact sensitivity test, friction sensitivity test and thermal decomposition tests were applied to study the influence of different ferrocene derivatives on the sensitivities of ultra-fine AP/ferrocene mixtures.

Effects of HMX Crystal Characteristics on Shock Sensitivities: Crystalline Inter Voids, Particle Size, Morphology

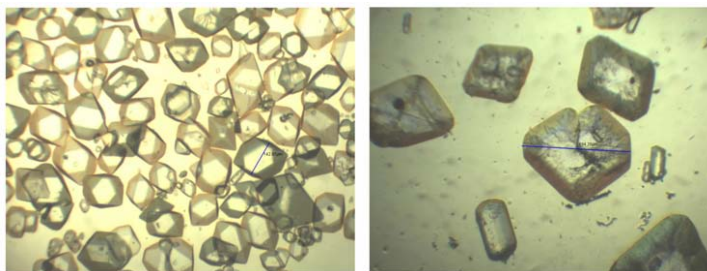

Effects of HMX crystal characteristics on the shock sensitivity were studied by using standard gap test method. Crystal defects type is one of major factors affecting shock sensitivity, the shock sensitivities of HMX with twin defects is higher than that of HMX without twin defects.

XU Rong, LI Hong-zhen, KANG Bin, LI Jin-shan, Huang Ming, LU Xiao-jun

Chinese Journal of Energetic Materials, 2011, 19(6): 632–636

Effects of Phase Impurity on Stability and Security of Aluminum Hydride

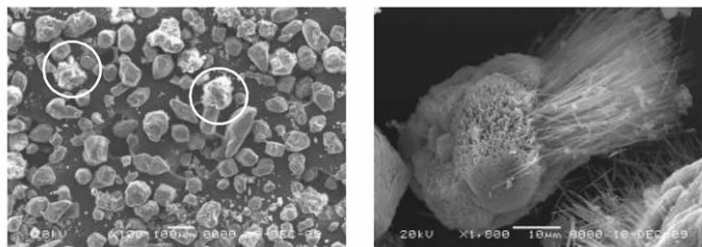

The existence of α' -, β -, γ -aluminum hydride polymorphs affect the thermal stability aluminum hydride sample. The existence of the impurity polymorphs increases the friction sensitivity, impact sensitivity and electrostatic sensitivity.

ZHU Zhao-yang, MA Yu, ZHANG Su-min, WANG Hong-zhi, CAO Yi-lin

Chinese Journal of Energetic Materials, 2011, 19(6): 637–640

Theoretical Study on Structure and Explosion Performance for Aluminum Triazide

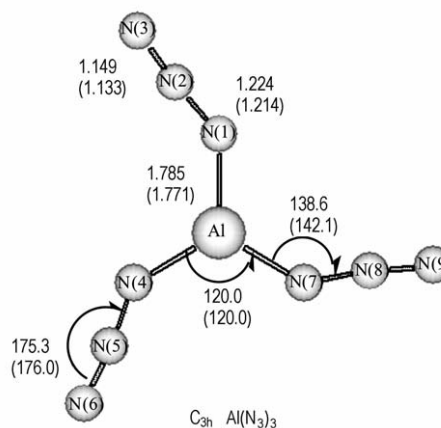

The geometrical structure of aluminum triazide has been optimized at the B3LYP/6-311G* level of theory. Its potential as an explosive compound and high-energy ignition agent has been investigated by calculating detonation parameters of aluminum triazide and composite explosive of AN, TNT and aluminum triazide, respectively.

ZHOU Xue-song, LUO Qiong, JIAO Qing-jie, PU Yang

Chinese Journal of Energetic Materials, 2011, 19(6): 641–645

Thermal Kinetics of Sulphur-free Black Powder

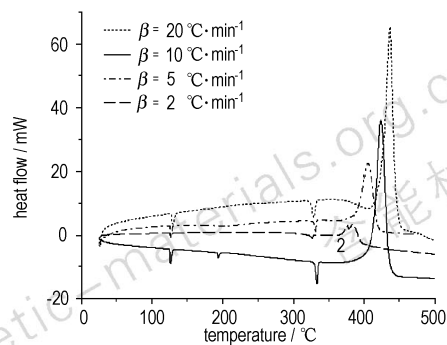

Using DSC results at different heating rates, kinetic parameters are calculated based some kinetic equations. Based on the parameters the thermal hazards of sulphur-free black powder and ordinary black powder are analyzed.

YU Jin-yang, CHEN Li-ping, JIANG Xi-bo, PENG Jin-hua
Chinese Journal of Energetic Materials, 2011, 19(6): 646–649

Dynamic Vacuum Stability Test (DVST) Method (IV): Thermal Decomposition of HMX

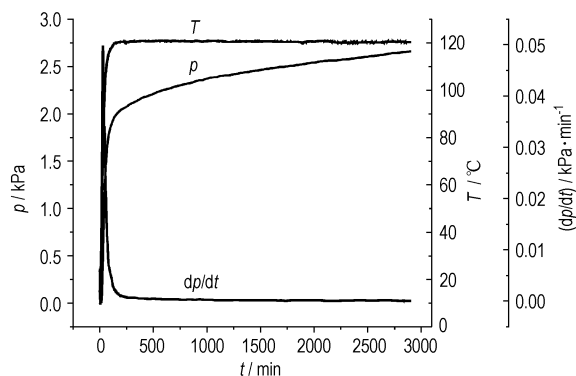

LIU Rui, YIN Yan-li, ZHANG Tong-lai, YANG Li, ZHANG Jian-guo, ZHOU Zun-ning, QIAO Xiao-jing, WANG Wen-jie, WANG Li-qiong
Chinese Journal of Energetic Materials, 2011, 19(6): 650–655

The partial decomposition reaction kinetics of HMX at six temperature points from 100 °C to 150 °C was studied by dynamic vacuum stability test (DVST).

Thermal Sensitivity of Energetic Materials Characterized by Accelerating Rate Calorimeter (ARC)

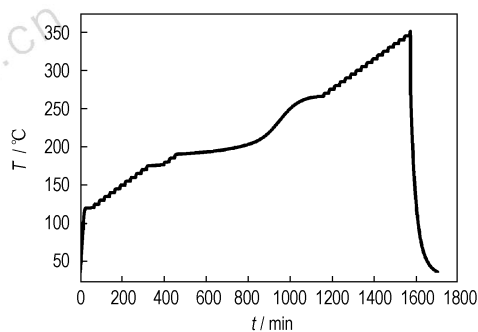

A method using accelerating rate calorimeter (ARC) to test thermal sensitivity of energetic materials was put forward. The decompositions of four solid explosives Pentaerythritol tetranitrate (PETN), Hexogen (RDX), Octogen (HMX), 2,4,6-Trinitrotoluene (TNT) and two liquid energetic materials Nitroethane (NE), 2-Ethylhexyl nitrate (EHN) were studied by ARC. Temperature corresponding different time to maximum rate under adiabatic condition (θ) was calculated.

LIU YING, YANG Qian, CHEN Li-ping, HE Zhong-qi, LU Yan, CHEN Wang-hua
Chinese Journal of Energetic Materials, 2011, 19(6): 656–660

Thermal Safety and Compatibilities with Silicone Rubber Cushion and Polyurethane Adhesive of PBX Specimen Based on HMX

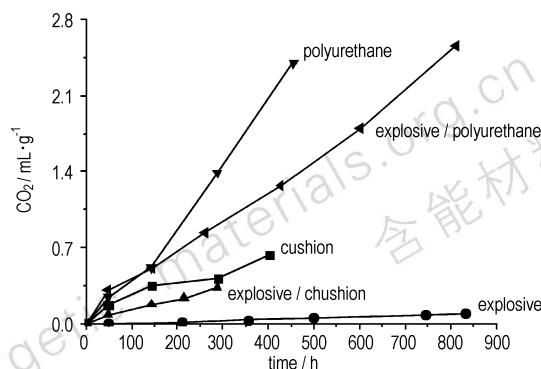

CHEN Jie, PENG Qiang, QIAN Wen, WANG Li-yan, ZUO Yu-fen, CHI Yu

Chinese Journal of Energetic Materials, 2011, 19(6): 661–663

The thermal safety of polymer bonded explosive (PBX) specimen based on HMX and their compatibility with contacted materials, silicone rubber cushion and polyurethane adhesive were studied by chemical reactivity test.

Cook-off Test of HNS under Sealed Condition

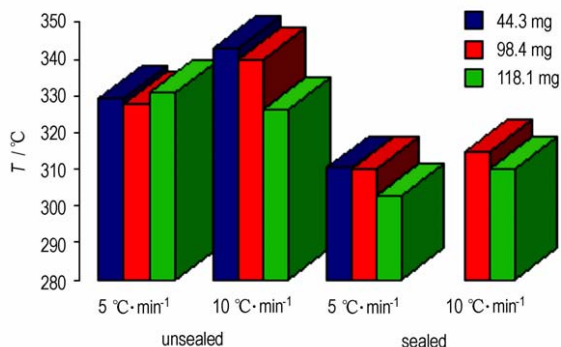

DU Zhen-hua, ZHANG Rui, TONG Hong-hai, LI Fang, FU Dong-xiao

Chinese Journal of Energetic Materials, 2011, 19(6): 664–668

The thermal behavior of sealed HNS explosive pellets with different sizes at $3.3\text{ }^{\circ}\text{C}\cdot\text{h}^{-1}$, $5\text{ }^{\circ}\text{C}\cdot\text{min}^{-1}$ and $10\text{ }^{\circ}\text{C}\cdot\text{min}^{-1}$ has been investigated using cook-off test. The responses of HNS pellets were judged by the damage or distortion of the sample tubes, the damage of its vulnerable place and the depth of steel dents.

Influence Factors of Slow Cook-off Characteristic for Solid Propellant



ZHAO Xiao-bin, LI Jun, CHENG Li-guo, WANG Ning, WANG Zheng, CHEN Zhong-e, WANG Chen-xue, QIN Chao, CHENG Xin-li

Chinese Journal of Energetic Materials, 2011, 19(6): 669–672

The influence factors of slow cook-off characteristic of typical solid propellant, such as HTPC propellant and GAP propellant, were studied by means of slow cook-off experimental device and thermocouple and pressure transducer, including formulation, burning rate, heating rate, restriction condition, and free volume. It indicates that the formulation composition, restriction condition have a remarkably effect on the response extent of the slow cook-off of solid propellant.

Accelerated Aging on Effect of Safety for Explosive Parts

GAO Da-yuan, SHEN Chun-ying, WEN Shang-gang,
HUANG Yi-min, LI Jing-ming

Chinese Journal of Energetic Materials, 2011, 19(6) : 673 –678

The accelerated aging test of temperature 75 °C, 100 d and temperature 65 °C, 180 d were done respectively. For the novel and accelerated aging explosive parts, the thermal explosion test, the fast cook-off test and the drop test were carried, the testing data were analyzed comparatively. The results show that the thermal safety and the impact safety of explosive parts are receded after accelerated aging.

Comparison of Aging Models of Polymer Bonded Explosives

ZHANG Guo-hui, WEI Xing-wen, CHEN Jie, SHU Yuan-jie,
SONG Mian-xin

Chinese Journal of Energetic Materials, 2011, 19(6) : 679 –683

The methods of three aging models were summarized to study the data of the aged HMX based PBX, and the lifetime at 20 °C was predicted by three methods. The time when the lost 0.2% of the total mass at 50 °C and 60 °C were also predicted.

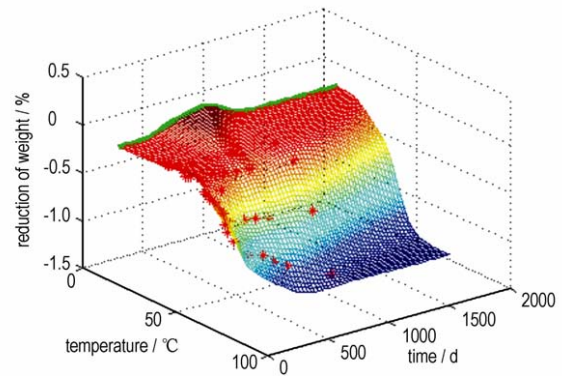

One-dimension Dynamic Tensile Properties of PBX

LAN Lin-gang, WEN Mao-ping, LI Ming, PANG Hai-yan,
JING Shi-ming

Chinese Journal of Energetic Materials, 2011, 19(6) : 684 –688

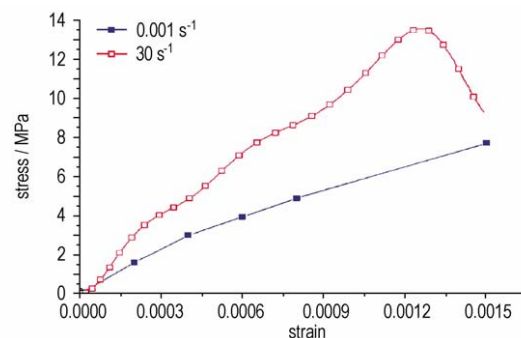

The dynamic tensile strength in the reflected SHTB was gotten. It showed dynamic tests beared high tensile strength. Dynamic tensile destroyed obvious different with quasi-static results.

Experimental study on the Shock Wave Sensitivity Response of Gun Propellant

CHEN Xiao-ming, JIN Peng-gang, ZHANG Heng, LIU Lai-dong,
SONG Chang-wen, ZHANG Zou-zuo, ZHAO Ying

Chinese Journal of Energetic Materials, 2011, 19(6) : 689 –692

The shock wave sensitivity of gun propellant was studied. The different compositions and shock wave response of shape gun propellant of wers studied.

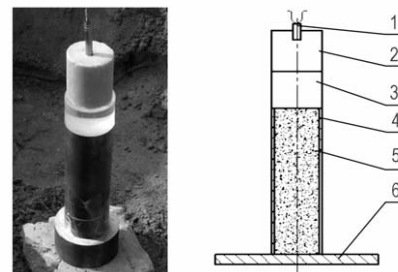

Experimental Measurement of Safety Parameters of DIANP

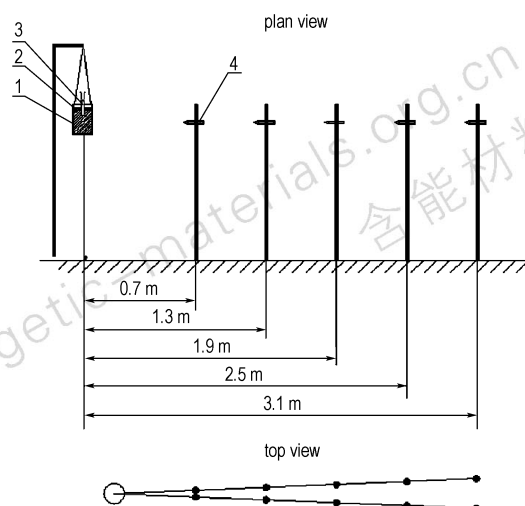

WANG Jian-ling, JI Yue-ping, GAO Fu-lei, GUO Wei,
REN Song-tao
Chinese Journal of Energetic Materials, 2011, 19(6) : 693 –696

The safety property parameters of 1, 5-diazido-3-nitrazpentane (DIANP) were studied by Koenen's test, TNT equivalent experiment, impact sensitivity test and friction sensitivity test.

Investigation of the Deflagration to Detonation Transition in Pressed High Density Explosives

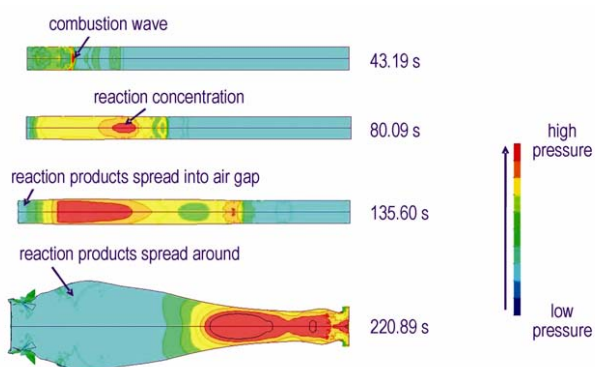

CHEN Lang, WANG Fei, WU Jun-ying, WANG Chen, LU Feng, HUANG Yi-min, DAI Xiao-gan, WEN Yu-shi
Chinese Journal of Energetic Materials, 2011, 19(6) : 697 –704

Deflagration to detonation (DDT) experiments of pressed PBXC03 with different confinements were conducted, and a DDT calculating model was established. Explosive deformations and pressure distributions at different times with different confinements was described.

Influence of Pressed Explosive Charges Density and its Distribution on Impact Safety

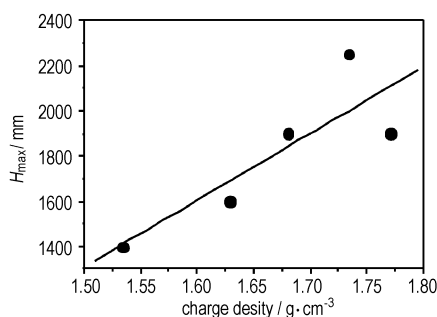

WANG Shu-ping, WANG Xiao-feng, JIN Da-yong
Chinese Journal of Energetic Materials, 2011, 19(6) : 705 –708

Information was reported on the influence of density and density distribution of pressed explosive (including A-IX-II explosive, composition B, and HMX-based aluminiferous explosive) charges on impact safety.

Plastic Charge Stability Analysis of Supersonic Projectile During Penetration of Concrete Targets

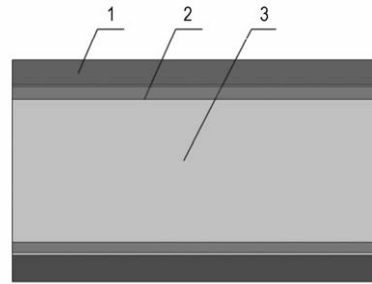

ZHANG Xu, CAO Ren-yi, TAN Duo-wang

Chinese Journal of Energetic Materials, 2011, 19(6) : 709 –714

A simplified dynamic friction model was constructed, and charge stability is analyzed based this interface friction model.

Vulnerable Response of Gun Propellant by Bullet Impact Test



ZHANG Zou-zou, YANG Li-xia, LIU Lai-dong, ZHANG Heng
Chinese Journal of Energetic Materials, 2011, 19(6) : 715 –719

The single-based propellant of small grain were explored and having a bright flame simultaneity, when the samples were impacted by 12.7 mm armor-piercing projectiles at a impact velocity of $(850 \pm 20) \text{ m} \cdot \text{s}^{-1}$.

Simulation on Influence of Residual Rocket Motor Propellant on Warhead Damage Effect



three group

four group

NEPE

GAP

WANG Ning, ZHAO Xiao-bin, WANG Chen-xue, TIAN Jun
Chinese Journal of Energetic Materials, 2011, 19(6) : 720 –724

The influence of different types of composite solid propellants on warhead charge/propellant system damage effect was studied by lead cylinder compression test, lead block volume test, shock wave overpressure and impulse test. The presence of propellant all enhances lead cylinder compression value of warhead charge /propellant system in different degrees.

Hazard Property of the RDX-CMDB Propellant

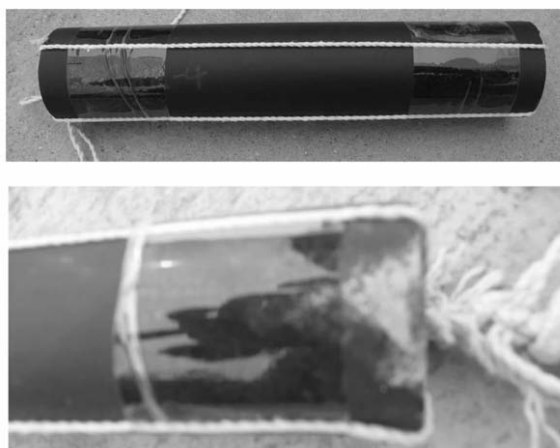

Some typical experiments including detonator sensitivity, gap, deflagration-to-detonation transition (DDT), drop, thermal stability, explosion temperature, slow cook-off, and electrostatic sensitivity were carried out to study the stimulation-response characteristics of the screw-extruded RDX-CMDB propellant.

QIN Neng, PEI Jiang-feng, WANG Ming-xing

Chinese Journal of Energetic Materials, 2011, 19(6): 725–729

Safety of Continuous Grinding and Mixing Machine Used Specially for Exposed Ammonium Nitrate Explosive

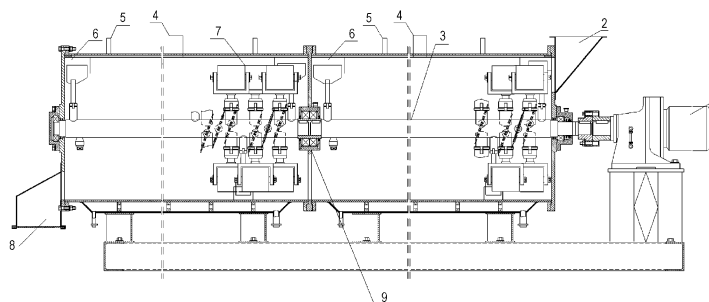

The safety of grinding and mixing machine was studied by analyzing the design of its structure and production limit experiment. In the experiment, the safety was researched via the plugging material conditions and the detonation velocity of explosive.

LUO Hai-tao, HU Bing-cheng, Lü Chun-xu, LIU Zu-liang

Chinese Journal of Energetic Materials, 2011, 19(6): 730–734

Synthesis and Characterization of Novel Insensitive Energetic Plasticizer 3-Nitrofurazan-4-monomethyl Ether

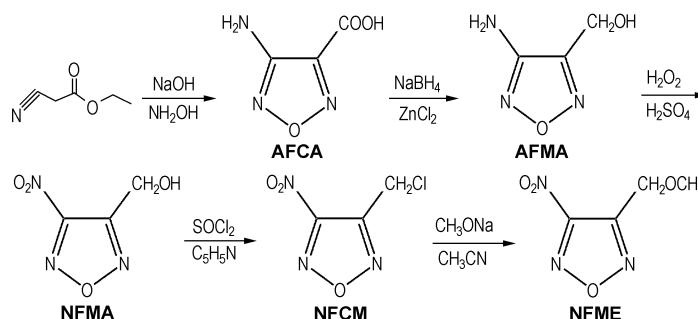

With ethyl cyanoacetate as starting material, 3-nitrofurazan-4-monomethyl ether (NFME) was synthesized through cyclization, reductio, oxidation, chlorination and etherification reactions.

SHEN Hua-ping, LU Yan-hua, CAO Yi-lin, HE Jin-xuan

Chinese Journal of Energetic Materials, 2011, 19(6): 735–738

Preparation and Characterization of Nano-composite Energetic Materials Fe₂O₃/Al/RDX

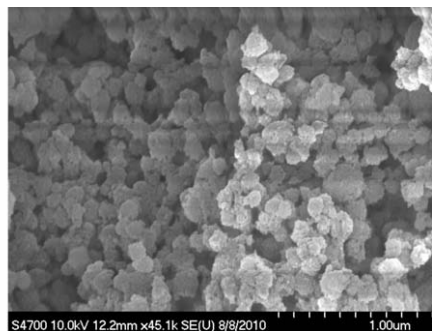

WANG Rui-hao, ZHANG Jing-lin, WANG Jin -ying, PAN Jun-jie, ZHANG Jun

Chinese Journal of Energetic Materials, 2011, 19(6) : 739 –742

Nano energetic materials Fe₂O₃/Al/RDX was prepared and characterized. Its friction and impact sensitivity are compared with that of RDX.

One-pot Synthesis of 2-Nitro-4,5-dicyano-1H-imidazole

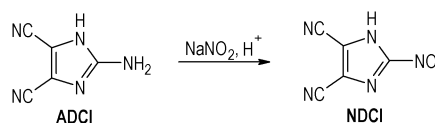

XU Cheng, BI Fu-qiang, FAN Xue-zhong, LI Ji-zhen, WANG Bo-zhou, GE Zhong-xue, LIU Qing, ZHANG Guo-fang
Chinese Journal of Energetic Materials, 2011, 19(6) : 743 –744

Using ADICI and large excess sodium nitrite as the raw materials, one-pot synthesis of NDCI was reported, and its molecular structure was characterized by IR, ¹³C NMR, ¹⁵N NMR and X-ray diffraction analysis.

Growth and Machining of RDX Single Crystal

LI Hong-zhen, ZHOU Xiao-qing, XU Rong, HUANG Ming, WANG Shu-cun
Chinese Journal of Energetic Materials, 2011, 19(6) : 745 –746

RDX single crystals grown in two different solvents which properties have an important role in the morphology and crystal quality. RDX single crystals can be machined into single crystal with 1 – 20 mm thickness.

A Low-cost Preparation Technology of High Energy Density Material DNTF

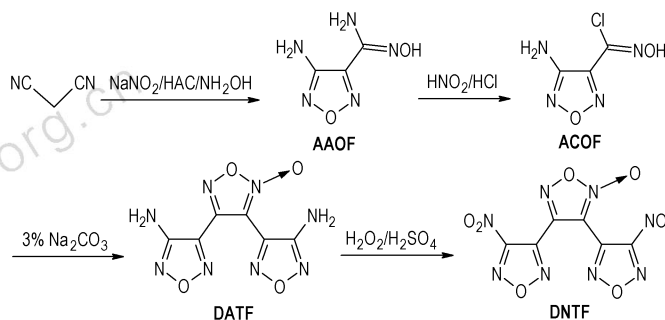

WANG Jun, ZHOU Xiao-qing, ZHANG Xiao-yu, LI Jin-shan, HUANG Yi-gang
Chinese Journal of Energetic Materials, 2011, 19(6) : 747 –748

A low-cost preparation technology of DNTF was obtained. This technology can completely put DNTF in practical application in new high-power munitions.

Executive editor: WANG Yan-xiu JIANG Mei; Computer typesetter: ZHANG Gui-hong